

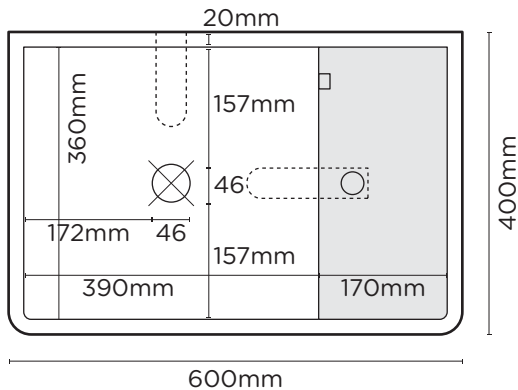

Shelf 03

For tight spaces, powder rooms, hotel and apartment blocks this full sized Shelf basin has a space for soap or a tap hole, and a further option of overflow, wall mount or surface mount. Simple install after tiles, this basin ticks all the boxes.

PLAN VIEW



SECTION VIEW

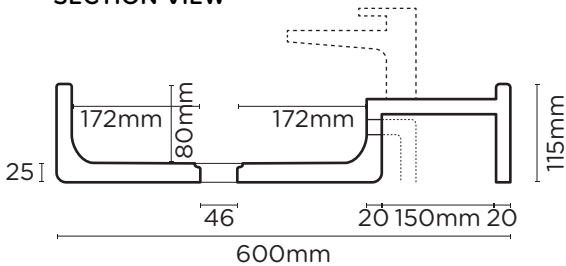

Note: Overflow pipe separate. For surface mount basin, a second hole in bench top is required.

SPECIFICATIONS

MATERIAL	UHP Concrete
FINISH	Matte / Low Sheen
WEIGHT	16.5kg (13.6lbs)
DIMENSIONS	L600mm x W400mm x H115mm (L23.6in x W15.7in x H4.5in)
BOWL CAPACITY	9.8L (2.6gal)
TAP HOLE	35mm (1.37in)
OVERFLOW AVAILABLE	White, black or chrome (housing option) Kit Chrome - Overflow basin requires 32mm waste
WASTE RQD	32mm or 40mm Standard (not provided by Nood, Overflow basin requires 32mm waste)
WARRANTY	24 months
WASTE HOLE SIZE	46mm (1.8in)
WALL THICKNESS	20mm (0.8in)
OPTIONS	Surface Mount / Wall Hung / Taphole / Overflow
WALL HANG RQD	Mount after tiling - basin back has a recess to cater for bracket
ORIENTATION	Shelf to the right only.

WALL HUNG BRACKET

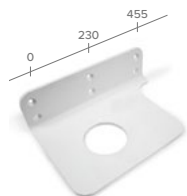

8mm aluminium powdercoated. Bracket, fixings, adhesive provided with each wall hung basin purchased.

L342mm x W505mm x H74.5mm
(L13.4in x W19.8in x H2.9in)

THICKNESS

Wall Hang Bracket: 8mm (0.3in)
L Bracket: 3mm (0.1in)

WEIGHT

Wall Hang Bracket: 3.5kg (7.72lbs)
L Bracket: <250g (0.5lbs)

INSTALLATION

Timber Wall: tiny.cc/udkhlz
Masonry Wall: tiny.cc/Ogkhlz

Basin to be mounted after tiling

AVAILABLE COLOURS

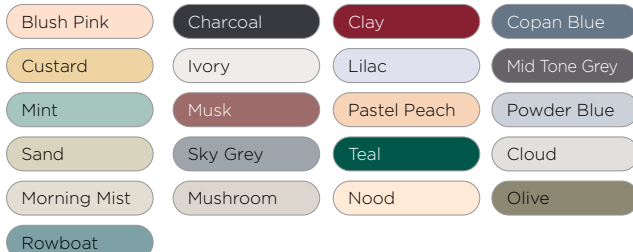

SUGGESTED TAP / FAUCET POSITION & LENGTH

WALL HUNG BASIN

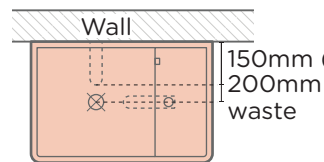

SURFACE MOUNTED BASIN

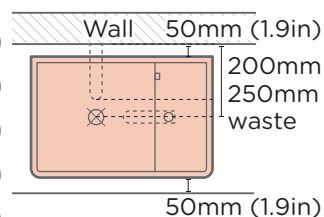

INSTALL HEIGHT

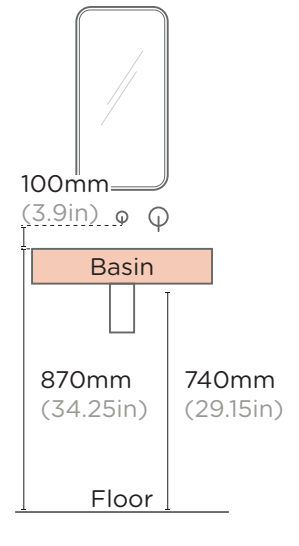

All dimensions are estimate. We suggest waiting until receiving Nood basins before cutting holes in cabinetry items. Colours of concrete may vary slightly.

Shelf 03

VANITY LAYOUTS

