

Backrest Removeable Wall Cover Plate

Nero

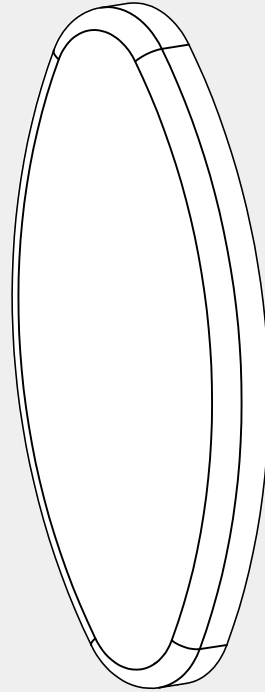

Versions:202311

Drawing

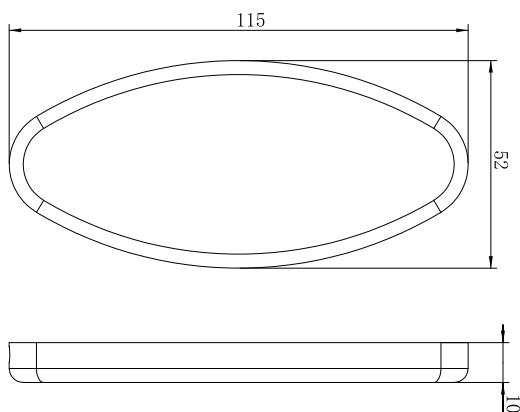







Specifications

SKU
NRCR0005

Warning:

These rails are designed to be mounted onto wall studs or masonry walls. Installation is recommended to be completed by qualified trades person who complies with the AS 1428.1-2009 design for access and mobility standard. It is recommended rail location is determined by a qualified occupational therapist or trained professional to the AS 1428.1-2009 standard. Correct installation is required to ensure safe, long term operation. Incorrect mounting can result in reduced capacity of the rail which can result in injury to user and damage to the wall.

Finish

 Chrome NRCR0005CH	 Gun Metal NRCR0005GM	 Brushed Bronze NRCR0005BZ
 Matte Black NRCR0005MB	 Brushed Gold NRCR0005BG	 Brushed Nickel NRCR0005BN

Features

1. Australian owned and designed.
2. Gun metal, brushed gold and brushed bronze colours are PVD coated for long term durability.

*Dimensions are nominal measurements only.

Installation Instruction

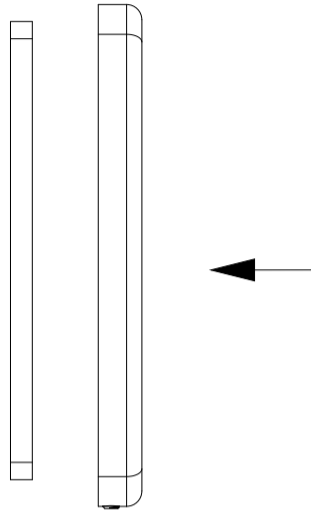

1. Angle cap into wall bracket to get the cap to sit flush.

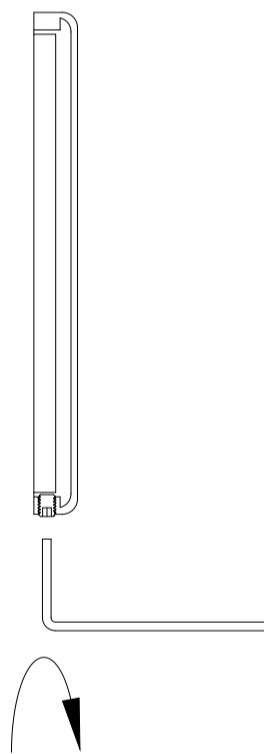

2. Tighten grub screw to secure cap in place. Do not over tighten.

Nero

info@nerotapware.com.au
nerotapware.com.au

11-13 Buontempo Road
Carrum Downs Vic 3201



**MECCA CARE
DDA CARE 32MM**