

4000 SERIES SINKS

4000 SERIES 1 AND 3/4 RIGHT HAND BOWL SINK

SPECIFICATIONS

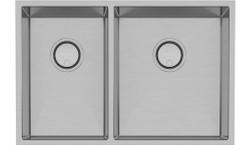
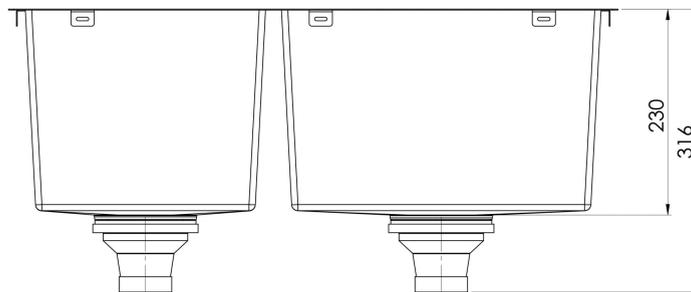
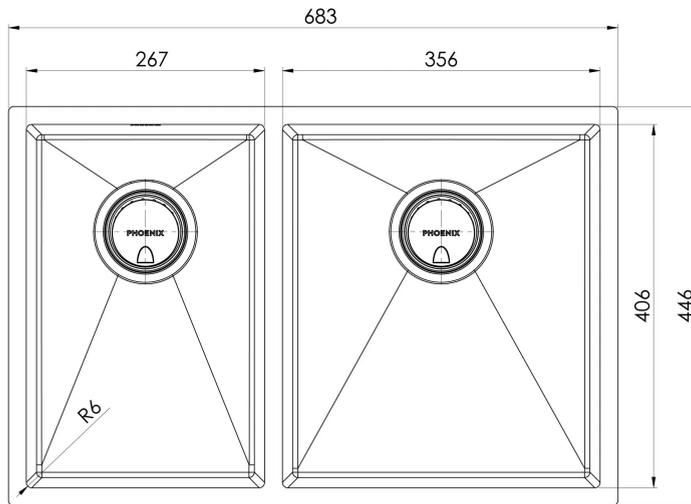

AVAILABLE IN



310-5102-51
Stainless Steel



310-5102-16
Brushed Black

INFORMATION

MAINTENANCE AND CARE:

- All surfaces should be cleaned with mild liquid detergent or soap and water.
- Do not use cream cleaners or citrus based cleaning products, as they are abrasive.
- Use of unsuitable cleaning agents may damage the surface.
- Any damage caused in this way will not be covered by warranty.

33 Litre / 11 Litre Capacity

Please visit <https://www.phoenixtapware.com.au/warranty> to view the full warranty



While we aim to ensure the specifications shown are correct at time of printing, Phoenix Tapware reserves the right to make modifications without prior notice. Always use the physical product measurements for mark-ups and roughing-in as the line drawing shown may differ from the actual product over time. All measurements are shown in millimetres. Colours may vary from image shown.

Ph: +61 3 9780 4200
12/11/2024
phoenixtapware.com.au