

130mm Square Tile Insert Floor Waste 80mm Outlet

Nero

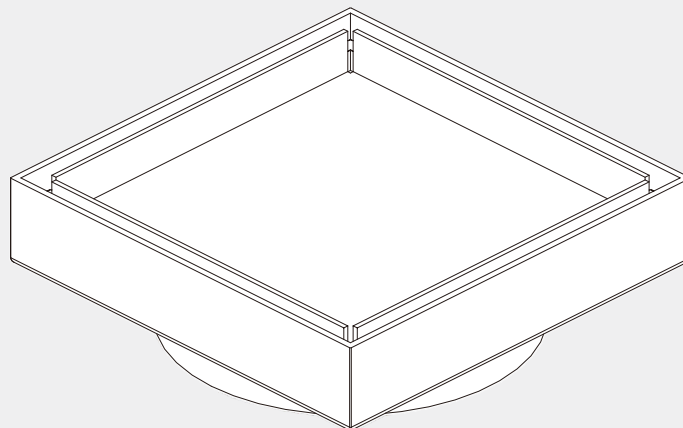

Versions:202311

Drawing

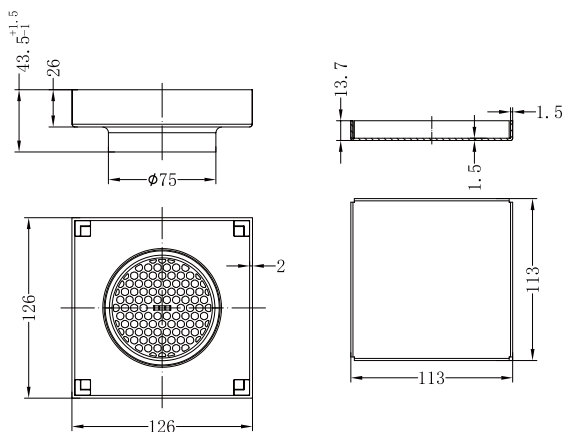



Specifications

SKU
NRFW007
Watermark License
WM-032203

Packaging Includes

1 x floor waste

Finish

- | | | |
|--|--|--|
|  Brushed Nickel
NRFW007BN |  Gun Metal
NRFW007GM |  Brushed Bronze
NRFW007BZ |
|  Matte Black
NRFW007MB |  Brushed Gold
NRFW007BG | |

*Dimensions are nominal measurements only.

Installation Instruction

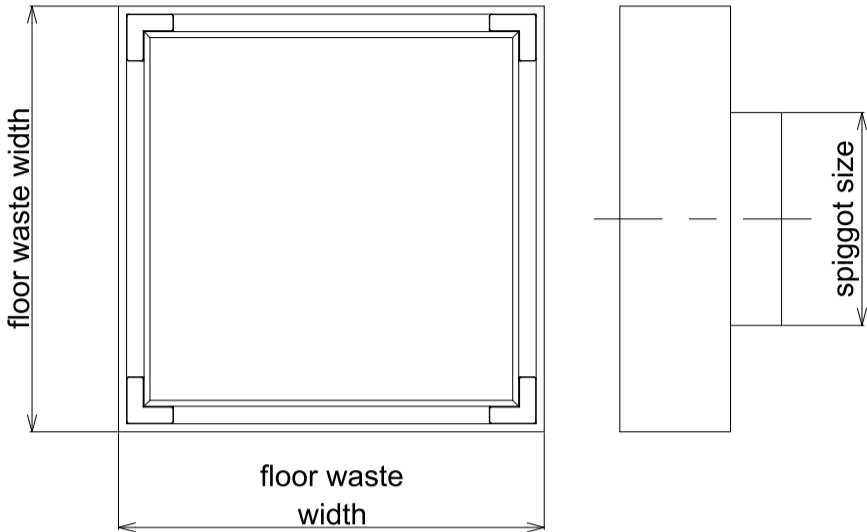

The installation of this Shower Grate is subject to the requirement of National Construction Code Volume. The Plumbing Code of Australia (PCA), associated reference standards as applicable at the time and WMTS040.

The Maximum live load bearing is 100KG.

Floor Waste Width	Spigot Size	Nominal OD Floor Waste Pipe
126mm	75mm	90-100mm PVC

NOTES:

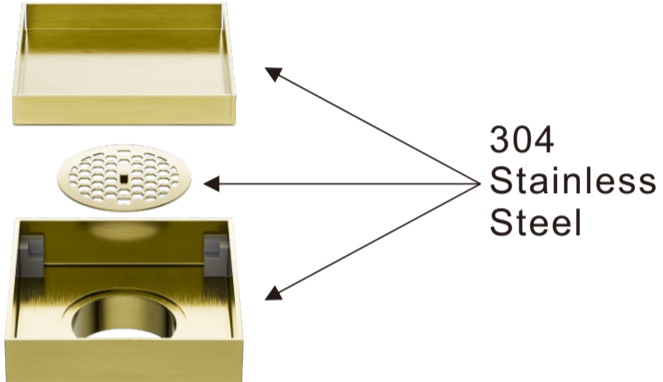

304 Stainless Steel



1

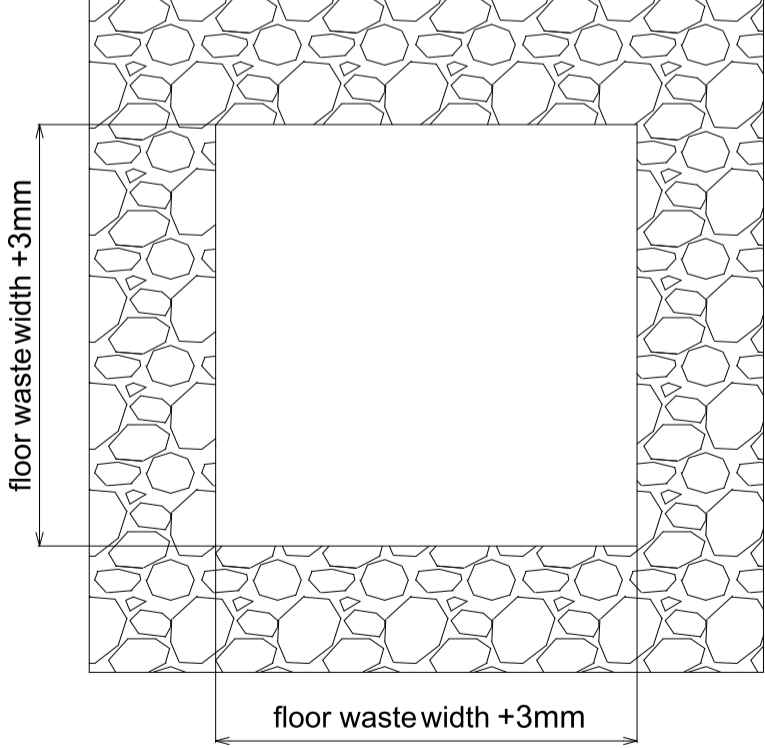

1. Cut grate to suit floor waste allowing at least 3mm of clearance in overall length to facilitate removal for cleaning.

2

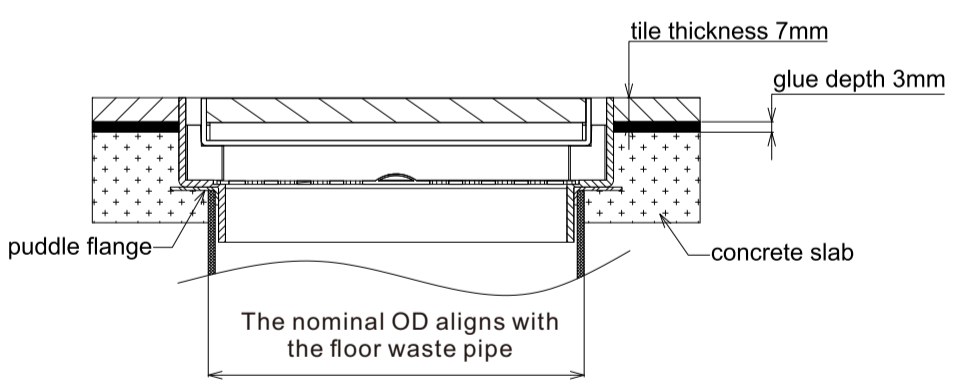

2. Install floor waste as above picture.

Note: it can be installed 2 ways: tile insert placement and normal placement.

Nero

info@nerotapware.com.au
nerotapware.com.au

11-13 Buontempo Road
Carrum Downs Vic 3201

