

York Wall Basin Set

Nero

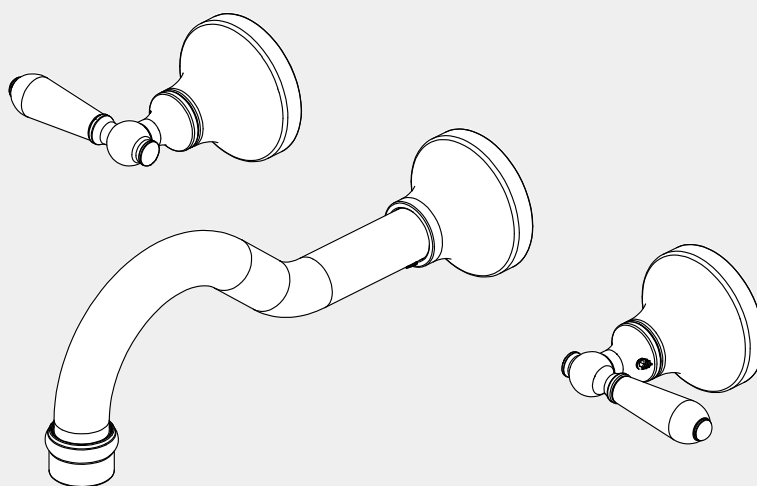

Versions:202401

Drawing

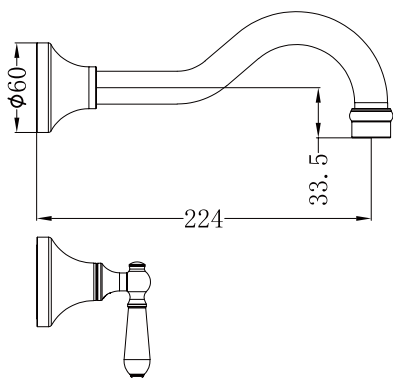
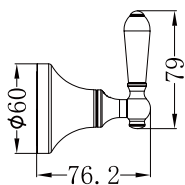

Specifications

Watermark License

WM-060073

Temperature Rating

Min 1°C-Max 75°C



Pressure Rating

Min 150kpa - Max 500kpa

Packaging Includes

1x Spout
2x Wall Top Handles

Finish & SKU

	CHROME WITH WHITE PORCELAIN LEVER NR692107a01CH		MATTE BLACK WITH METAL LEVER NR692107a02MB
	CHROME WITH METAL LEVER NR692107a02CH		AGED BRASS WITH WHITE PORCELAIN LEVER NR692107a01AB
	CHROME WITH BLACK PORCELAIN LEVER NR692107a03CH		AGED BRASS WITH METAL LEVER NR692107a02AB
	MATTE BLACK WITH WHITE PORCELAIN LEVER NR692107a01MB		

*Dimensions are nominal measurements only.

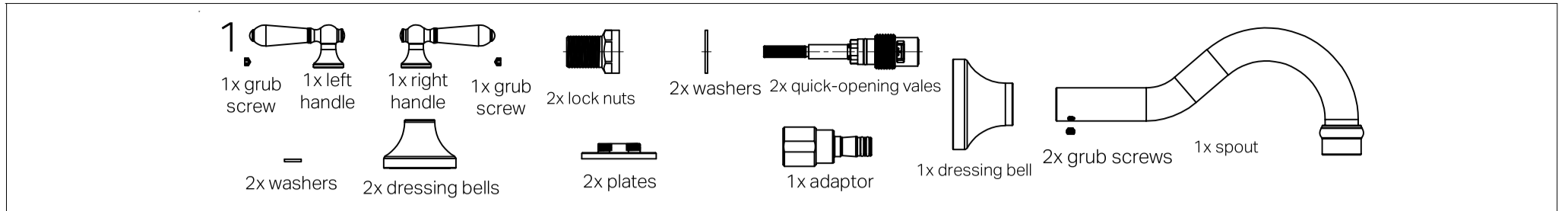

2

- Install the breach (not included) in advance.

3

- Position the quick-opening valve to the breach body, and screw it in place tightly.
- Slide the washer onto the valve's end, secure with the locking nut. Ensure all parts are snug.
- Test for leaks.

4

- Screw the plate and cutting gauge onto the lock nut tightly, ensuring a secure fit.

5

- Trim the excess thread flush with the cutting gauge.
- Smooth the trimmed edge.
- Test for leaks.

6

- Remove the cutting gauge.
- Attach the dressing bell.
- Place the washer inside the handle, fit it onto the tap body, and secure with the grub screw.

7

- Secure the adapter to the water outlet with Teflon tape. Note: length of the water outlet is 19mm max.
- Fit the dressing bell over the adapter.
- Slide the spout into the dressing bell and fasten using the grub screw.
- Test for leaks.

8

Position the handles as shown in the image.

Nero

info@nerotapware.com.au
nerotapware.com.au

11-13 Buontempo Road
Carrum Downs Vic 3201

